

METOLIGHT® LED-Panellight RDL 6262-40-110

The METOLIGHT® LED panel light RDL 6262-40-110 is an ultra-flat, lightweight LED flat panel light for installation in grid ceilings with a 625 mm grid. With an installation depth of just 10 mm, it can also be used as a flat wall lamp or as a photo light background. Optional brackets allow suspended mounting or ceiling / wall surface mounting. The panel luminaire has a UGR value of <22, which is ideal for offices, commercial lighting, libraries, schools, etc. according to the EN 12464: 2011 standard.

METOLIGHT®
LED-Panelleuchte RDL-6262-40
40 Watt - 110 lm/W
62 x 62 cm



ASMETEC
www.asmetec-shop.de

The built-in LEDs on an aluminum core circuit board are mounted on the side of the aluminum frame, a laser-cut diffuser with thousands of tiny lenses distributes the light evenly and without shadows on the opal luminaire surface.



The sturdy aluminum frame is matt white as standard, but can be manufactured in many RAL colors on request, taking minimum delivery quantities into account. It also serves as a heat sink for the LEDs. Even in continuous operation, the luminaire does not get warmer than approx. 35 ° C. The panel luminaire corresponds to LM 78 and LM 79 with an efficiency of 110 lm / W

This luminaire is also available with an efficiency of 150 lm / W and has almost the same brightness with a power consumption of just 24 watts, corresponding to energy class C.

With a luminous flux of 4800 lm, this flat LED luminaire easily replaces conventional luminaires with 4 x 18 watt fluorescent tubes with a total power consumption of approx. 110 watt (incl. ballast).

The closed luminaire is also easy to clean, the external, plug-in power supply unit is easy to replace. Dimmable versions (PMW or 0-10 Volt, DALI) are also available.

We offer this luminaire in 4 light colours at CRI Ra > 80:

Warm white	2800 - 3300K
Nature white	3800 - 4200K
Pure white	4800 - 5300K
Cold white	5800 - 6500K

Advantages at a glance

- For ceiling installation with a 625 mm grid
- Replaces grid ceiling lights with 4 fluorescent tubes
- High color rendering accuracy with CRI Ra > 80
- 70% savings in electricity costs compared to fluorescent tubes
- Average LED life up to 40,000 operating hours (70% at Tp 25 ° C)
- Immediately full Luminosity without flickering or preheating
- Very low heat generation - no risk of burns
- No UV radiation below 400 nm, no infrared rays
- Flicker-free, hum-free, workplace-friendly light
- Easy to clean
- CE and RoHS compliant
- corresponds to energy class E
- 3-year warranty

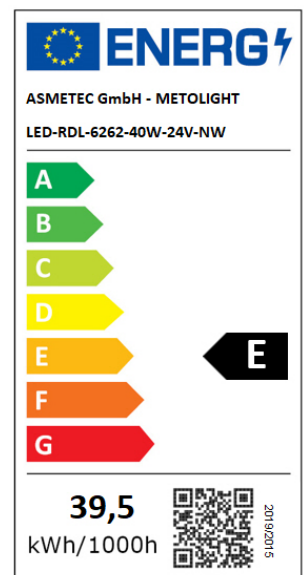

Technical Data

Voltage	110 – 240 V AC (ext. driver)	Warm white	2800-3500K – ca. 3900 lm
LED Voltage	25-42 V DC - 800-1050 mA	Nature white	3800-4500K – ca. 4200 lm
Power	41 W incl. driver	Pure white	4800-5500K – ca. 4300 lm
Power factor	> 0.90	Cold white	5800-6500K – ca. 4300 lm
Dimmable	Optionally, depending on driver	CRI Ra	> 80
Environment Storage	-15°C - + 40°C -15°C - + 50°C	Intensity Nature white	ca. 225 lux – 2,5 m ca. 155 lux – 3,0 m
Sizes	620 x 620 x 10 mm	Beam angle	ca. 120°
Weight	2,9 kg	Protection class	IP52, IK04
Standards	CE, ENEC, RoHS	Front	Mikroprismatic lens, PMMA

Light Distribution Diagram

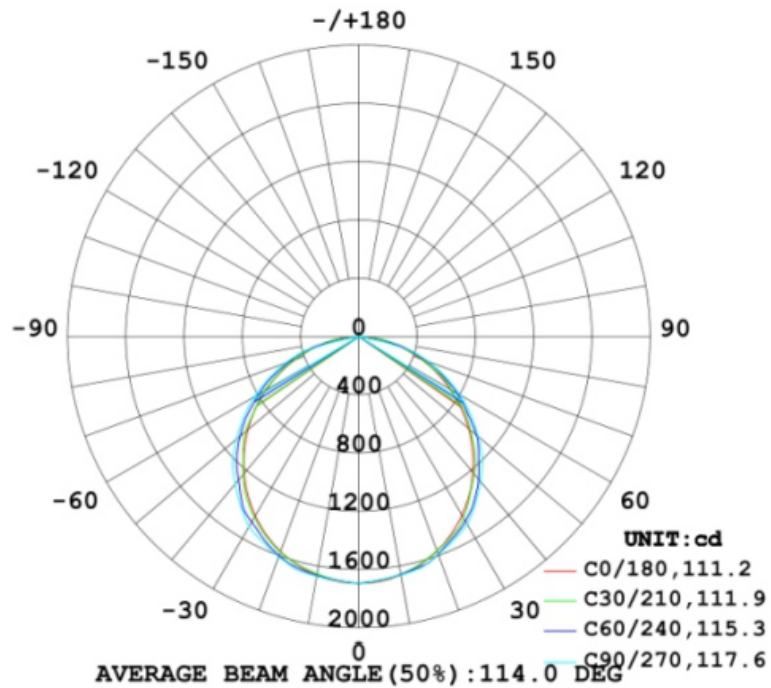

Sizes:

60 x 60 cm

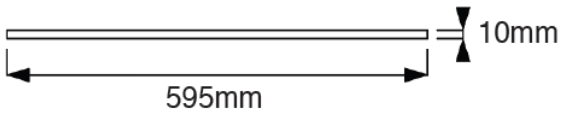
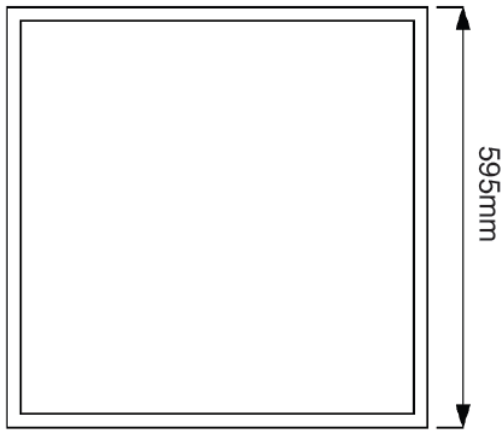

62.5 x 62.5 cm

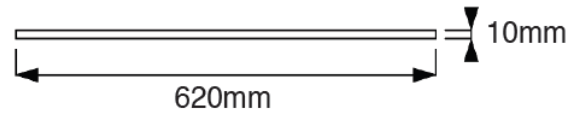
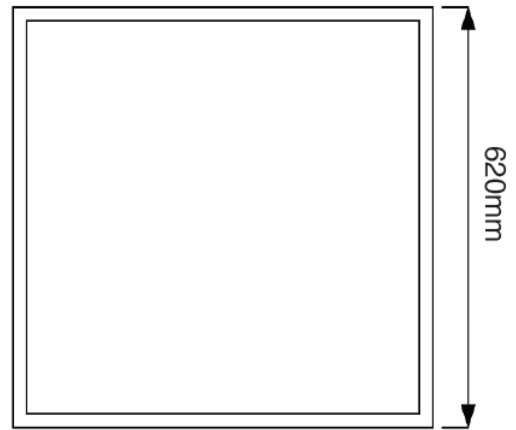

Electrical connection:

Only use special driver supplied with the luminaire.

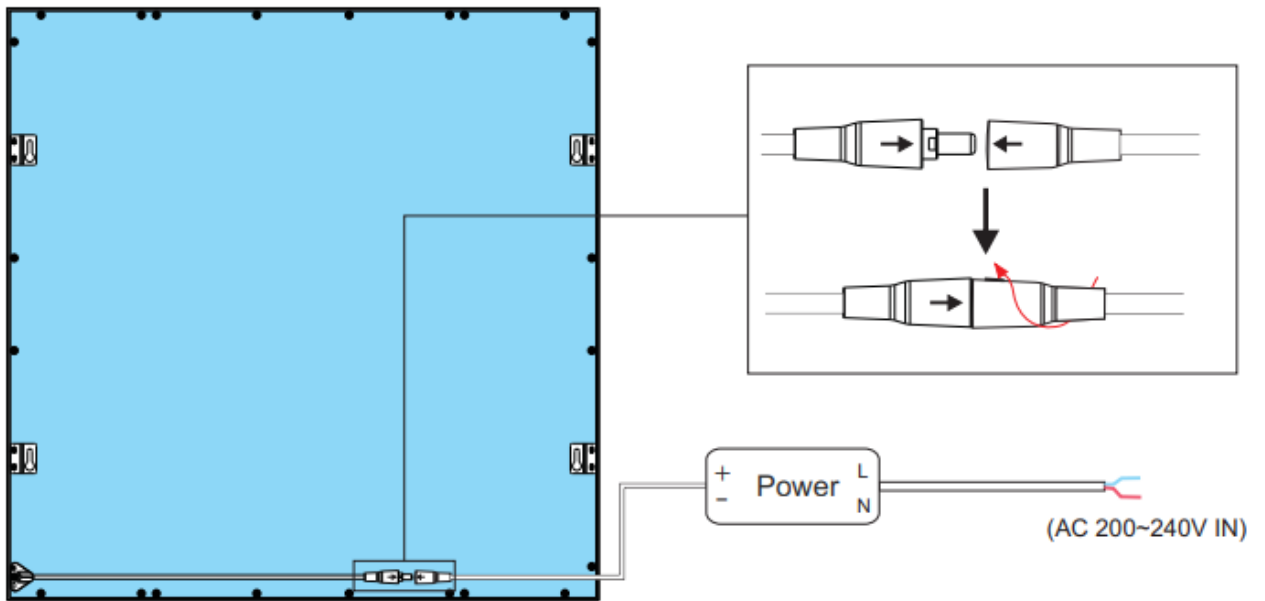

Mounting possibilities:

Inlay into grid ceilings (check grid size!)

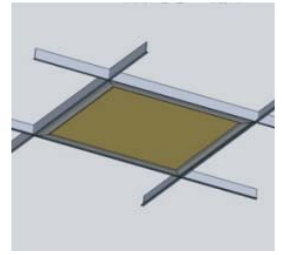
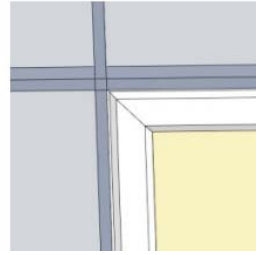
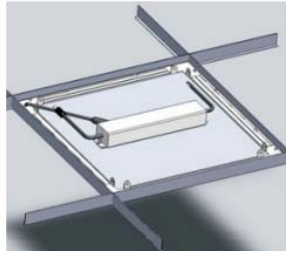
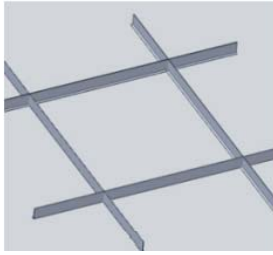

With optional spring clips:

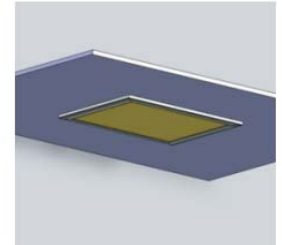
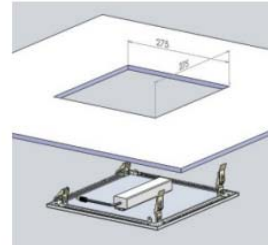
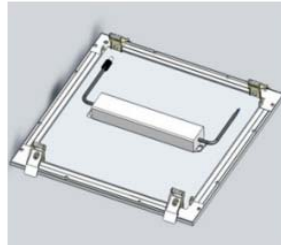
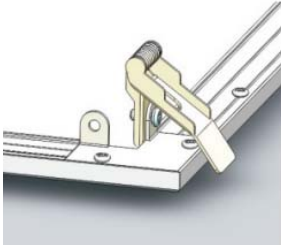

With optional pendant ropes:

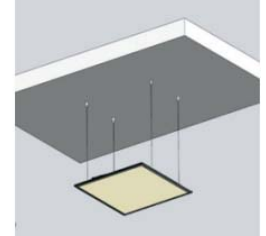
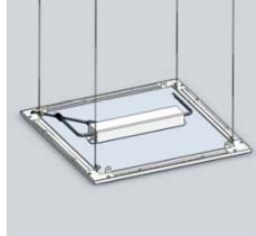
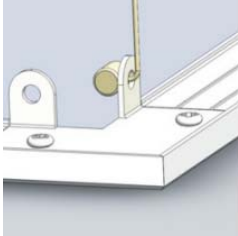

With optional frame



The above statements are based on our present knowledge. Our statements should not be interpreted as a guarantee of characteristics. The use of our products by our customers is subject to different conditions, therefore none of our customers are relieved of the responsibility of testing our products by themselves. A liability for consequential damage will not be accepted in any case. For damage resulting from the use of this information we can only be held responsible if there is evidence of malice or negligence on our part. This data-sheet replaces any previous data sheets.

ASMETEC, METODRILL, METOCHECK, METOLIGHT, METOSTAT, METOCLEAN and METO are registered trade marks of ASMETEC GmbH.
LED-RDL-6262-40-110-DB-E.DOCX, VERSION SEP-21